

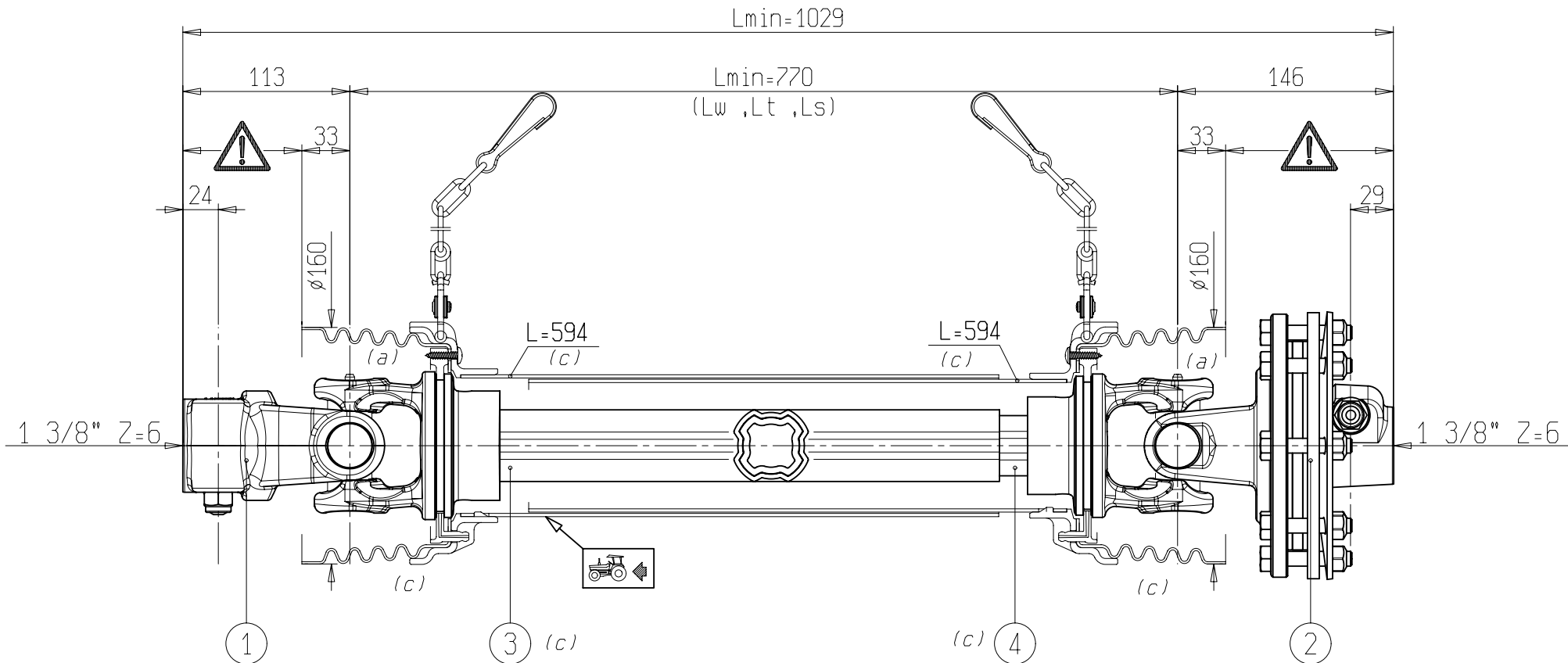





\*

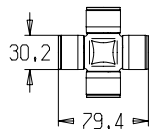
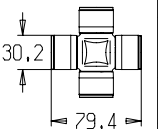

**WARNING!**

SECTIONS  OF THE ASSEMBLY MARKED ARE NOT SHIELDED AND MUST BE SHIELDED BY AN INTERACTIVE GUARDING SYSTEM. BONDIOLI & PAVESI DECLINES RESPONSIBILITY IF PROPER GUARDS ARE NOT PROVIDED OR MAINTAINED.

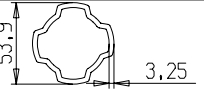
c	AGGIORNATO GRAFICAMENTE FASCIE, STANDARDIZZATO CODICI TUBI CARDANICI, PROTEZIONE, RIDOTTO ESPLOSO IN LIV. 3, MODIFICATO COD. POS. 29 (ERA 5661G9093), 30 (5662G9071), 97 (ERA 4DS607701FX) SULL'ESPLOSO, POS. 1 (5090G0353) E RIFATTO CARTIGLIO.	Bonini	2/8/2007
b	ERA 6DG337003.	MAGOTTI	4/4/2005
a	AGGIUNTO CODICE CROCIERE ED INGRASSATORI SUI CUSCINETTI.	SPENNATO	28/1/2004
Rev.	Descrizione Modifica	Operatore	Data

(b)	1	CODICE CODE 5090G0361	LATO TRATTORE TRACTOR SIDE	LATO MACCHINA IMPLEMENT SIDE	TIPO-TYPE SFT-S6	CLIENTE / CUSTOMER 4600160 BYPY HYDRAULICS & TRANSMISSIONS LTD	RIF. CLIENTE / CUSTOMER REF.	
	2	CODICE CODE 661G37203R FU32 750 Nm			DATA / DATE 23/02/02	DISEGNATO / DESIGNED BY M.FREDDI	TIPO DI MACCHINA / TYPE OF IMPLEMENT	
3	 L=620	30,2	30,2	LUNGEZZA MAX IN LAVORO MAX WORKING LENGTH Lw=1061	STUDIO / DESIGN	ORIGINE / ORIGIN TRS6R077004	SPEC. PER POS. 1 E 2	
4	 L=635	46,9	4,5	LUNGEZZA MAX TEMPORANEA MAX TEMPORARY LENGTH Lt=1158	NOTE / NOTES			CODICE / CODE DS60077FX000001
		760 min <sup>-1</sup>	M max 3000 Nm	LUNGEZZA MAX NON IN ROTAZIONE MAX LENGTH AT STANDSTILL Ls=1207			REV. C	